

WE REDUCE YOUR CONSTRUCTION TIME!

Modern construction
made in Germany.

SPECIAL

For planners and
architects:
p. 13-19

**NMT: NEW
MANUFACTURING
TECHNIQUES**

Library room
1000 (A)

Time Saving

+

Lower Costs

+

High Quality

=

Success

Designed
developed and
made in Germany



AWARDS

- *Innovation prize for the BT-Spannschloss®*
- *Winner of the „Grand Prix of the Mid-Market“*
- *Innovation Award for the MagFly® AP*
- *„AVW Entrepreneur Award“*
- *Recognition for successful international activities*
- *Recognition for entrepreneurship*





Where innovations happen

MODERN CONSTRUCTION MADE IN GERMANY

Dear readers,

„The future of construction starts here.“

What started in 1991 as a regional wholesaler has today evolved into an internationally renowned company. We are always close to our customers and are always a step ahead with innovations and new ideas.

We provide the concrete processing industry with innovative solutions and simplified work processes with significant time-savings.

The continuous development and high quality of our products have afforded us with numerous certificates, patents and successful building inspection approval certificates, and you can benefit from this too!

Alongside our extensive product range, we can provide you with consulting, planning and implementation services for new or existing plants in the field of precast plants. The focus of our daily operations is always our customers - we are only happy if the customer is happy too!

We hope you enjoy finding out more about our products and look forward to the start of an inspiring partnership.

CONTACT

*B.T. innovation GmbH
Sudenburger Wuhne 60 _ 39116 Magdeburg
Tel. +49 (0)391 - 7352-0*

Management: Felix von Limburg

.....
*Construction Site Sales:
Tel. +49 (0)391 - 7352-12
E-Mail: baustelle@bt-innovation.de*

*Prefabricated Parts Sales:
Tel. +49 (0)391 - 7352-66
E-Mail: fertigteilwerk@bt-innovation.de*

*Architects and Planners:
Tel. +49 (0)391 - 7352-28
E-Mail: architekten@bt-innovation.de*

*Marketing:
Tel. +49 (0)391 - 7352-33
E-Mail: marketing@bt-innovation.de*

.....
www.bt-innovation.de
.....

*Felix von Limburg
(CEO B.T. innovation)*

We unite ...

PROGRESS, SCIENTIFIC ADVANCEMENT
AND COMPETENCE



*Reproduction of the
NEAT-TUNNEL*

*using the BT-Spannschloss®
in the „Swiss Museum of
Transport“*

BT-PRODUCTS

Sealing systems

InnoElast® 06

ProElast® System **NMT*** 07

LiquidElast® 08

SynkoElast® 09

RubberElast® system 10

Special items

Syflex® 11

Spacers 12

Joining technology

BT-Spannschloss® **NMT*** 13

ThermoPin® **NMT*** 16

DowaTherm® 19

Magnet/shuttering technology

MagFly® AP 20

MultiForm / Window and Doorshuttering **NMT*** 21

MagFly® technology 22

FlyFrame® 23

Magnetic strips / MagFlex® / MagSwing® / Aluminium shuttering / U-profile 24

Magnet Type BR / GB / KU / FP / PL/E / E **NMT*** 25

Shuttering Manipulator **NMT*** 26

Battery and Butterfly shuttering **NMT* 27**

Consulting 29

Low Cost Housing 30

***NEW MANUFACTURING TECHNIQUE**

Our new manufacturing techniques are marked with the green corner!

InnoElast®

THE SEALING TECHNOLOGY OF THE NEW GENERATION

InnoElast® is a successfully used single-component polymer-modified sealant of the new generation used for sealing building joints, joints in industrial floors as well as connections for windows, doors, feedthroughs, roof areas and similar.

InnoElast® is an exceptionally low-shrink, permanently elastic and weather-resistant sealant with extremely high adhesive strength.

InnoElast® is environmentally friendly, meets many requirements for sealants and can be used both indoors and outdoors.

Benefits at a glance

- » Easy processing, permanent sealing, since it practically does not shrink
 - » Only one component
 - » Very high adhesive capacity; high adhesion even when fresh
 - » Weather and UV-resistant
- » Reacts with humidity to create a soft, rubber-like seal
 - » High chemical and microbiological resistance
 - » Can also be applied on damp substrates
 - » Can be used without a primer in just one application
 - » Solvent-free
 - » No plasticizers, isocyanates or silicones
- » Very high adhesion to concrete, steel, glass, wood, stone and various plastics

* * *

Image description:

1. Slicing of the tubular bag
2. Ensuring of the tubular bag into the applicator gun
3. InnoElast® will be spread equal into the joint

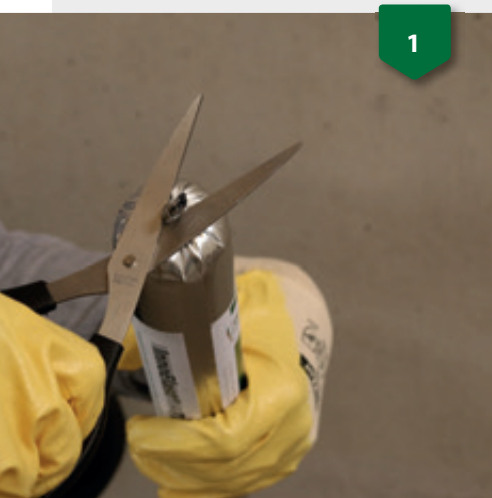

1



2

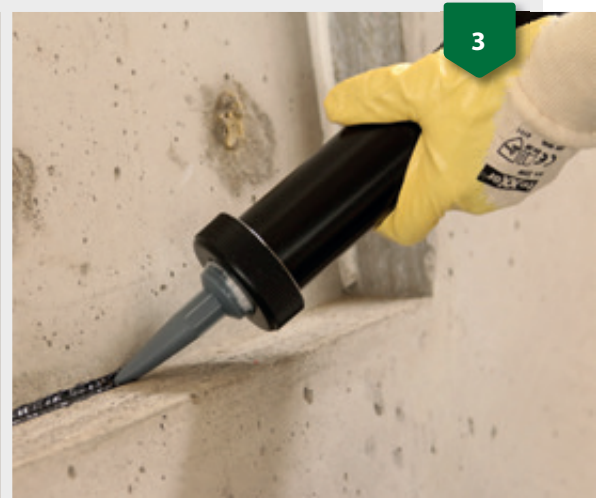

3

ProElast® System

THE SEALING SYSTEM OF THE NEW GENERATION

The ProElast® system is a successfully used, economical and application-friendly system for external, strip-shaped seals on working joints and controlled crack cross-sections in WU concrete construction.

The ProElast® system is an easily applied 2-part sealing system: a special EPDM foil and a highly effective adhesive, the InnoElast® Type 1 or 2. The ProElast® system is distinguished by its high water resistance as well as its high resistance to UV and weathering. In addition to the usual application possibilities for controlled crack joints in WU concrete construction, this system can also be used to permanently seal joints, cracks and crevices, such as those occurring in roofs, shafts and containers. The system thus has multiple possible applications.

Benefits at a glance

- » Fast and easy processing
- » Usable from -3°C to 40°C
- » Usable on damp substrates
- » Does not require a primer
- » Very high adhesion to concrete, steel, glass, wood, stone and various plastics
- » Tested pressurized water density with AbP* up to a 20 m water column
- » High chemical and microbiological resistance
- » Can be combined with other Elast products

*NEW MANUFACTURING TECHNIQUE

Image description:

1. Application as sealing roofs
2. Application as strip form sealing
3. Application in a groove

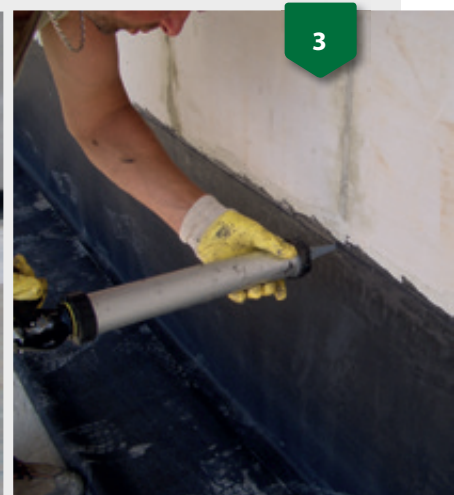

LiquidElast®

THE UNIVERSAL SEAL FOR SURFACES AND JOINTS

LiquidElast® is a universal, pressurized water-tight, liquid sealing system for various substrates. This single-component polymer-modified sealant has a wide range of uses, such as structural waterproofing in accordance with DIN 18195, composite waterproofing under various floor and wall coverings and for sealing roofs as well as a liquid seal for joints.

LiquidElast® type S and type V is an extremely effective crack-bridging (up to 5mm) sealing system that can be applied with a brush or spread. After hardening, it forms a „rubber-like“ waterproof membrane that protects various components.

Thanks to its simple and diverse processing possibilities, this system, which can be used in almost every weather and on many different substrates, offers maximum security even during the hard days of construction. Properties previously only available with two-component systems can be achieved with this single-component material, and in some cases can even be surpassed!

Benefits at a glance

- » Fast and easy processing
- » 1-component (reacts with humidity to form a soft, elastic rubber-like sealing membrane)
- » Bridges cracks (up to 5mm)
- » Can be applied to damp substrates
 - » Usable from 0°C
- » Suitable for repairing various (including bitumen-containing) roof seals
 - » Weather and UV-resistant
 - » Can be combined with other Elast products

Image description:

1. Product package LiquidElast® type S
2. LiquidElast® type V as joint filling
3. LiquidElast® type S as compound seal



SynkoElast®

THE PERFECT SEAL FOR CONSTRUCTION JOINTS

SynkoElast® is an innovative, very easy-to-use, highly economical internally located sealing tape which is made with a polymer-bitumen base. It can be used, for example, with working and controlled crack joints on structures made of water-impermeable concrete (WU concrete).

SynkoElast® bonds with the created concrete structure during hydration. It can be used to protect the outer reinforcement layer against corrosive attacks.

The simple application saves you time and money. SynkoElast® is simply pressed into the fresh concrete directly after concreting. This creates high laying capacity with minimal installation effort.

Benefits at a glance

- » Fast, easy application in fresh concrete
- » No sources of water contact
- » High laying performance due to minimal installation effort
- » Bonds with the concrete during hydration
- » Installation requires no further resources or tools
- » Resistant to acids, leachates, salt and liquid manure
- » General building inspection test certificate
- » Weather-resistant
- » Can be combined with other Elast products
- » Up to 150m per hour can be applied = high cost savings

* * *

Image description:

1. Application for element walls
2. Application for construction joint
3. Application for tank construction

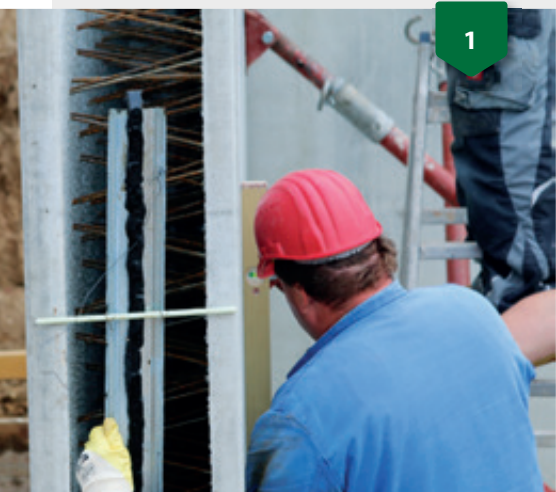

RubberElast®

THE SEAL FOR FINISHED PARTS THAT WILL LEAVE YOU AMAZED

RubberElast® is an extremely internationally successful sealing tape for precast concrete slabs. It is used in many water construction works, WU cellars and other construction applications in the WU field.

When assembling prefabricated parts, RubberElast® is applied to the first concrete part on one side. In the case of a horizontal joint, the contact pressure of the next concrete part is generally sufficient to permanently seal the joint. For vertical joints, the concrete components are usually tensioned, e.g. using the BT-Spannschloss®.

RubberElast® is not only characterized by its impermeability to gas and water but by its excellent resistance to weather and mechanical wear. RubberElast® retains its elasticity even at low temperatures. In addition to good adhesion to concrete, the sealing tape also has excellent adhesion properties to metals, glass and other materials. Especially suitable for flange connections.

Benefits at a glance

- » Approved by the MPA Braunschweig
- » Extremely high water and gas impermeability
- » Resistant to weathering, acids, alkali, salt and liquid manure
- » Good adhesion due to fast adhesion processing, no tools required
- » Immediately waterproof and stackable after installation

* * *

.....

Image description:

1. Application as sealing for shafts
 2. RubberElast®
 3. Application for frame apertures
-



1



2



3

Syflex®

THE FLEXIBLE SHUTTERING FOR STRAIGHT AND ROUND EDGES

With our flexible shell system Syflex®, straight lines, bends and edges can be manufactured easily. Syflex® is the optimal solution for sole plate, edge and strip foundation shuttering.

Increasing demands are being placed on the shape of the concrete. Shuttering round edges always creates a problem.

With this task, traditional shuttering systems take a lot of work, are extremely cost-intensive and are less flexible. Unwieldy, heavy wooden planks take time to install and negatively impact the workflow. Special shuttering is extremely cost-effective. The Syflex® shuttering system offers a solution which is easy to handle with a third of the weight of comparable wooden shuttering and can be installed without the need for hoists in the shortest possible time. The system allows the creation of shells for straight lines bends and edges with minimal effort, while also being reusable multiple times.

With Syflex®, you can create almost any shape out of concrete. But it isn't just foundations that can be optimally shuttered with Syflex®; the system has also proven itself with applications in road construction as well as gardening and landscaping applications. The versatile application options make Syflex® a true all-rounder on the shuttering market.

Benefits at a glance

- » Low weight (approximately 1/3 of the weight of comparable wood shuttering)
- » Individual shaping with on-site cut-to-order options, rounded shapes, memory effect, radii from 1m
- » Easy assembly/disassembly
 - » Shorter work time
- » Reusable, sturdy attachment with eccentric parts
 - » Outstanding cost savings
- » Levelling is accurate to the millimetre for peeling the concrete

Image description:

1. Building an Oceaneum with Syflex®
2. Syflex® as round shuttering for strip fundamentals



1

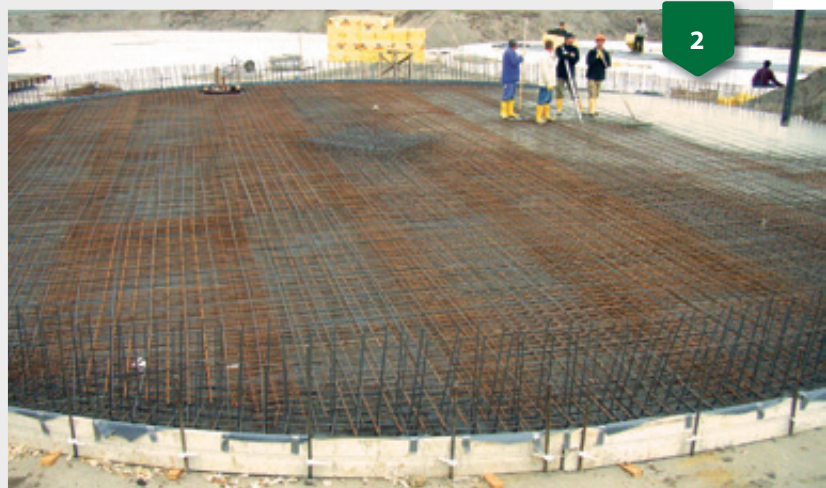

2

Spacers

THE COST-EFFECTIVE ALTERNATIVE

FROM PLASTIC TO STEEL:

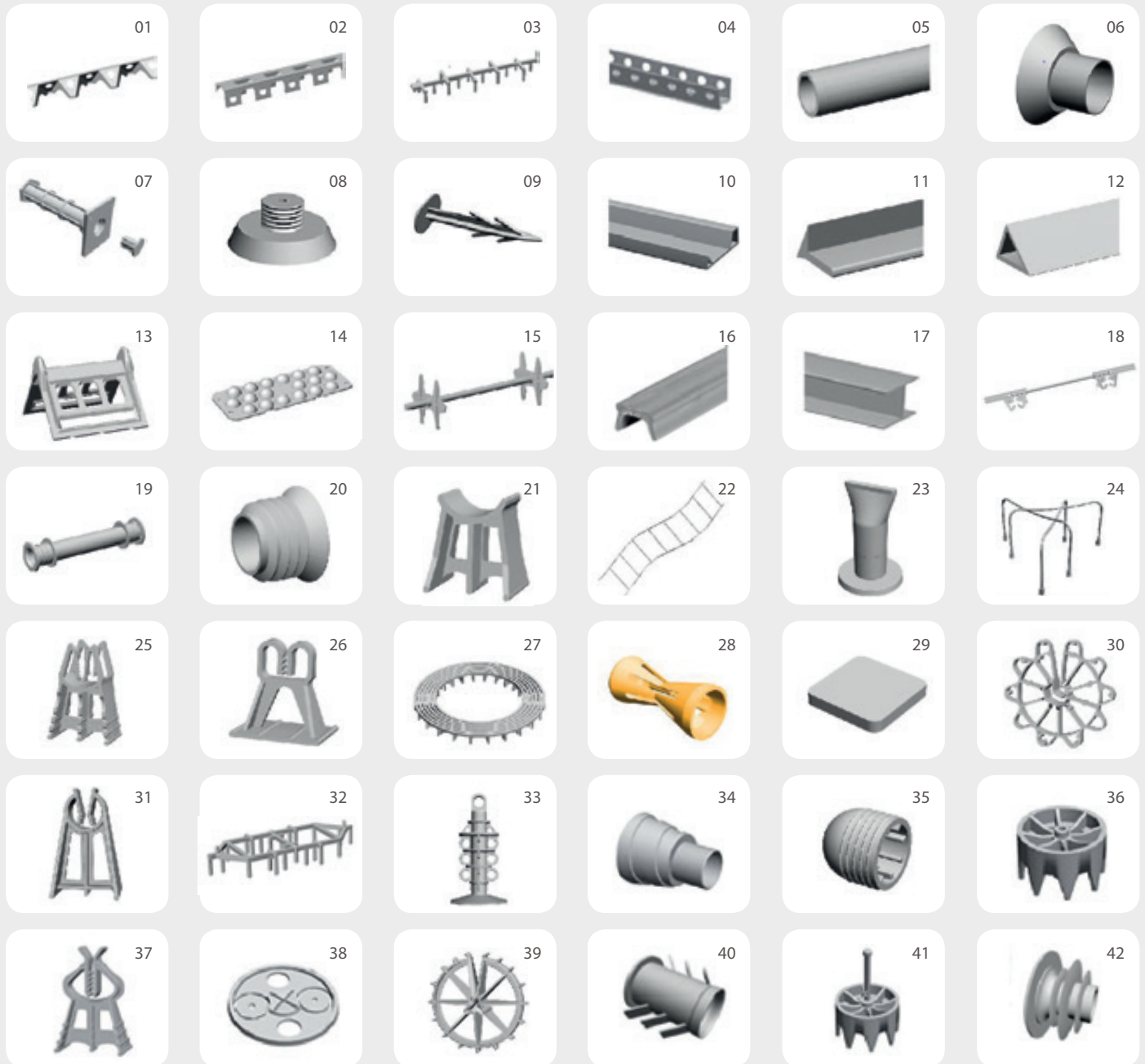

Other products you can find on our website: www.bt-innovation.de.
In addition you can send us your individual inquiry!

FROM FIBRE CONCRETE:



BT-Spannschloss®

POWERFUL CONNECTION FOR PREFABRICATED CONCRETE PARTS

The innovative BT-Spannschloss® allows the precise assembly and permanent constructional connection of prefabricated concrete parts with a predominantly static load in the tensile and transverse directions.

The turnbuckles are approved by the DIBt (Deutsches Institut für Bautechnik). The BT-Spannschloss® can also be used for constructive connections in the WU field in connection with corresponding sealing products, e.g. RubberElast®.

NEW: Now available with three-point connection.

APPLICATION POSSIBILITIES:

- Multi-storey industrial and residential construction
- Connection of foundation plates
- Connection of angle brackets in flood defence
- Connection in agricultural silo construction
- Also suitable for WU applications together with the RubberElast® seal

*NEW MANUFACTURING TECHNIQUE

Image description:

1. Assembly BT-Spannschloss®
2. 3-and 2-point connection BT-Spannschloss®
3. BT-Spannschloss® in combination with RubberElast®

Benefits at a glance

- » Can be combined with all approved anchor systems
- » Construction approval by the DIBt (Z-14.4-599) with statically proven load specifications
- » Expensive, difficult individual solutions are no longer necessary
- » Two- and three-point connection
 - » Easy, precise preparation of the recess by a wide range of magnetic and non-magnetic recess components
- » Extremely high savings of costs and time thanks to intuitive, fast installation
- » Capable of supporting high shearing- and tensile loads
 - » Certified monitoring



1

2

3

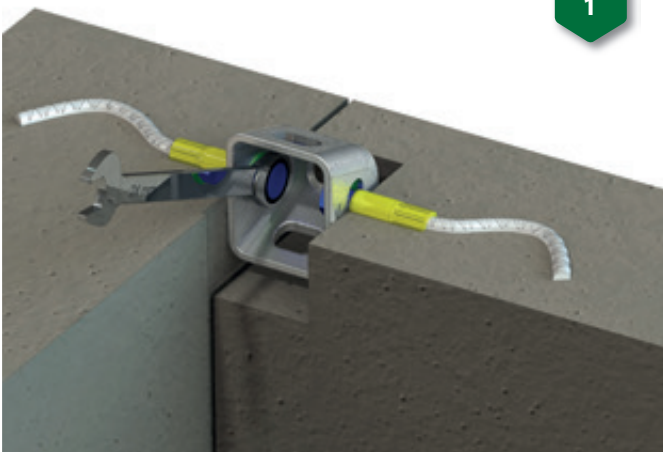

From good ideas...

AND SCIENTIFIC KNOW-HOW
PAIRED WITH PASSION AND THE SPIRIT OF INVENTION,
WE CREATE INNOVATIVE PRODUCTS



BT-Spannschloss®

*galvanized in size M12
(available in sizes M16 and M20
as well as in stainless steel)*

Specifications

BT-SPANNSCHLOSS®

BT-Spannschloss® M12

Turnbuckle for the force-transmitting connection of prefabricated concrete parts for predominantly static stress. The turnbuckle is attached to the prefabricated concrete parts using connection elements (screw or threaded rod with washer) which are screwed into the anchors of the prefabricated concrete parts.

Depending on the type of turnbuckle, connecting elements with an M12 thread and associated washers must be used.

- Tensile force: 33.7 kN in the direction of the connection element axle

- Lateral force: 9.4 kN perpendicular to the connecting element axis

When using the turnbuckles, the conditions listed in the General Building Inspection Approval (DIBt) must be observed.

When anchoring the connecting elements in the prefabricated concrete part (e.g. anchor sleeve, shaft anchor), the manufacturer's installation instructions must be observed.

BT-Spannschloss® M16

Turnbuckle for the force-transmitting connection of prefabricated concrete parts for predominantly static stress. The turnbuckle is attached to the prefabricated concrete parts using connection elements (screw or threaded rod with washer) which are screwed into the anchors of the prefabricated concrete parts.

Depending on the type of turnbuckle, connecting elements with an M16 thread and associated washers must be used.

- Tensile force: 43.5 kN in the direction of the connection element axle

- Lateral force: 26.2 kN perpendicular to the connecting element axis

When using the turnbuckles, the conditions listed in the General Building Inspection Approval (DIBt) must be observed.

When anchoring the connecting elements in the prefabricated concrete part (e.g. anchor sleeve, shaft anchor), the manufacturer's installation instructions must be observed.

BT-Spannschloss® M20

Turnbuckle for the force-transmitting connection of prefabricated concrete parts for predominantly static stress. The turnbuckle is attached to the prefabricated concrete parts using connection elements (screw or threaded rod with washer) which are screwed into the anchors of the prefabricated concrete parts.

Depending on the type of turnbuckle, connecting elements with an M16 or M20 thread and associated washers must be used.

- Tensile force: 52.2 kN in the direction of the connection element axle

- Lateral force: 24.8 kN perpendicular to the connecting element axis

When using the turnbuckles, the conditions listed in the General Building Inspection Approval (DIBt) must be observed.

When anchoring the connecting elements in the prefabricated concrete part (e.g. anchor sleeve, shaft anchor), the manufacturer's installation instructions must be observed.

ThermoPin®

ENERGY-EFFICIENT CONSTRUCTION WITH THE EFFECTIVE CONNECTION SYSTEM

The ThermoPin® connecting rod made of glass-fibre-reinforced plastic (GRP) enables the efficient production of core-insulated concrete parts. The ThermoPin® system consists of horizontally and possibly diagonally installed rods and is suitable for concrete prefabricated parts with a free-hanging or supported facing shell.

Thanks to the matching system components, the ThermoPins® can be installed quickly and reliably using appropriate production technologies. With its two conical wide-ned ends, the bar is simply concreted into the front and support shell during the installation of the prefabricated concrete parts and connects these together firmly. The fitted cuff ensures proper installation and serves as a water barrier. Since GFK barely conducts heat, the ThermoPin® decouples the front and support shell thermally, significantly increases the efficiency of the thermal insulation and improves the heat storage behaviour of the concrete parts.

This is achieved by deflecting the glass fibres, not by cutting. This results in high load-bearing capacity and high pull-out resistance of the rods in the concrete while maintaining a slim diameter.

Benefits at a glance

- » High level of efficiency during the production of concrete parts
- » Slim-line designs due to reduced concrete covering
- » Corrosion-resistant, alkali resistant
 - » Reduces the use of steel
 - » Improved heat storage action of wall elements
 - » Substantial energy savings, low heating costs
- » Price stability, as not reliant on steel prices
- » Approved by DIBt: Z-21.8-2055
- » Reduction of crack formation due to elasticity in the rod



*NEW MANUFACTURING TECHNIQUE

Image description:

1. ThermoPin® within a Sandwichwall
2. ThermoPin®
3. ThermoPin® in use

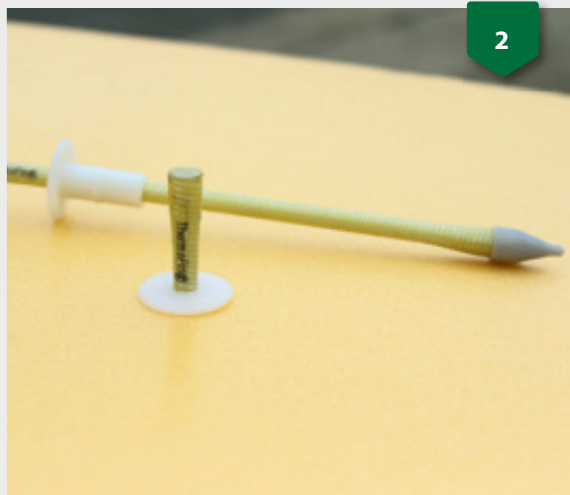
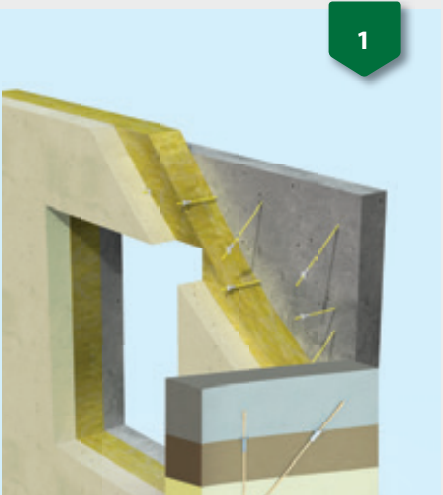

References

1. Geesthach
2. Residence
3. Pensa residence
4. Headquarter B.T. innovation



Specifications

THERMOPIN®

Flexible tie anchor for thermally isolated multilayer walls made from durable, high-strength glass fibre in an epoxy resin matrix; corrosion-resistant, chemical-resistant, electrically and magnetically neutral. With conical extension at the ends and fully intact glass fibres along the bar shaft.

Straight or horizontal bar version: Dimensions of the front layer (load fitting)

W x H x D = [cm]

Dimensions of the front layer (load fitting)

W x H x D = [cm]

Thickness of insulating layer = [cm]

Thickness of the in-situ concrete layer for element walls = [cm]

Total wall thickness = [cm]

Subject to different requirements after completed static development! Characteristic value of constant tension bearing capacity (50 years): 11.5 kN

E-module: $\geq 50000 \text{ N/mm}^2$

Length and version of the ThermoPins is customised for the construction project in question.

Unit: St

Horizontal anchor – ThermoPin TYPE H

For the production of core insulated sandwich or element walls with an upright facing shell, the following fasteners should be used to anchor the facing shell with the bearing shell:

Horizontal anchor with a bar diameter of 7.5 mm and conical extensions to 10.5 mm at the ends. The heat conductivity is 0.5 W/mK.

The horizontal anchor is made from non-corrosive, glass fibre-reinforced plastic and has a plastic spacer as a water barrier and installation aid. The horizontal anchor serves as a tensile and pressure rod in the sandwich or element wall. The exact length, as well as the arrangement and number of the horizontal anchors is determined by the static measurement.

Diagonal anchor - ThermoPin TYPE D

For the production of core insulated sandwich walls, the following fasteners should be used to anchor the facing shell with the bearing shell:

Diagonal anchor with a bar diameter of 7.5 mm and conical extensions to 10.5 mm at the ends. The heat conductivity is 0.5 W/mK.

The diagonal anchor is made from non-corrosive, glass fibre-reinforced plastic and has a plastic spacer as a water barrier and installation aid. In the case of a sandwich wall with a free-hanging attachment tray, the horizontal anchor must be used in addition to the diagonal anchor.

The diagonal anchor serves as a bearing anchor for transferring loads from the facing shell to the bearing shell.

The position of the anchor is tilted to an angle of 45° in the upright wall. The exact length, the arrangement and the number of the diagonal anchors are determined by the static measurement.

DowaTherm®

THERMALLY DECOUPLED SPACER FOR DOUBLE WALLS

The DowaTherm® double wall spacer consists of a rod made of high-performance fibreglass composite material and a new plastic foot.

It has a twin bracket. This makes it possible to combine the foot and allows the user the option of using fibreglass wads with an 8 or 10 mm diameter.

Its geometric design allows the foot to easily be pushed under the first reinforcement layer in accordance with the required concrete cover, ensuring a safe and vertical position without further attachment or aid. Its support points also allow the foot to serve as a spacer for reinforcement.

The DowaTherm® terminal is also available for the DowaTherm® double wall spacers. The complex storage and processing system offers space for up to 15,000 double wall spacers with a space requirement of only 1.5 m³. The foot and rod are stored separately and inserted as required. It also comes with a pendulum saw, which can be used to produce the necessary special lengths with minimum effort.

Benefits at a glance

- » Thermally separates the shells
- » Can be cut to the desired length
- » Individual assembly means low inventory requirements
 - » No corrosion
- » High availability of special lengths due to easy assembly

.....
Image description:

1. DowaTherm® in use
 2. DowaTherm® in use
-

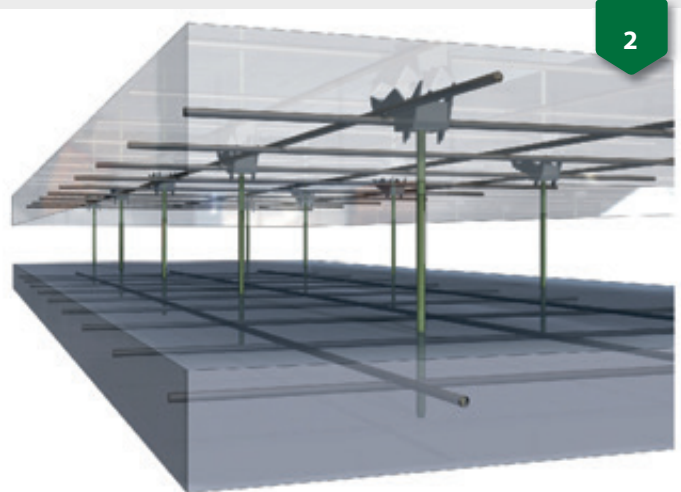
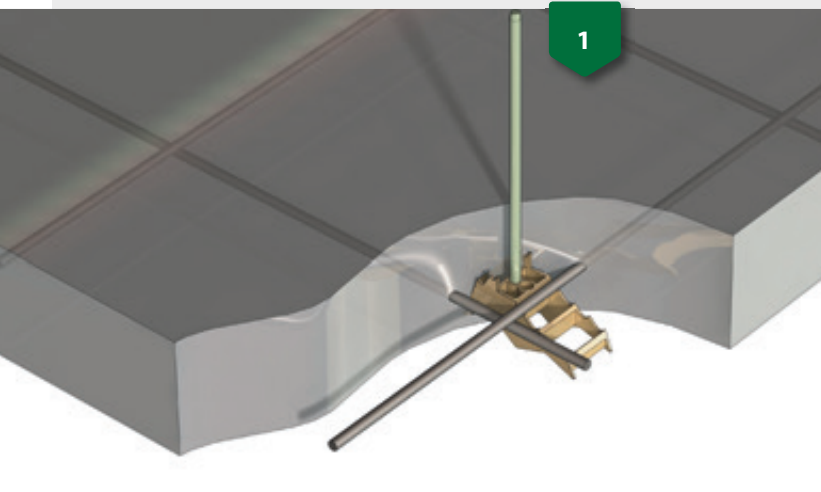

MagFly® AP

SUPER STRONG - LIGHTWEIGHT MAGNET TECHNOLOGY

*Can you improve a good, effective adhesion magnet?
Yes, you can!*

The MagFly®AP is the result of continuously developing the tried and true MagFly® universal magnet. With a housing made of aluminium, high-performance magnetic materials and an integrated adapter for multi-form and FlyFrame® shuttering systems, the new system magnet is equally a muscleman and a lightweight. With an adhesive force of 22,000 N and a total mass of only 5.40 kg, it has the best adhesive force mass ratio of its class worldwide.

Of course, the latest generation of magnets also contains the proven MagFly® technology for the easy positioning, aligning and pressing of shuttering and magnets.

Benefits at a glance

- » Very ergonomic design; its low weight and new lever design make carrying and handling a breeze
- » Extremely light, but massively powerful nonetheless!
- » Of course, the new MagFly® AP also has the integrated MagFly® technology for exact positioning
- » Precise securing of the magnet by the application of light hand pressure
- » The securely mounted cam lever means that additional loosening tools are not needed
- » Compact design with integrated adapter for MultiForm and FlyFrame®



.....
Image description:

1. Magfly® AP
 2. Magfly® AP in combination with MultiForm
-

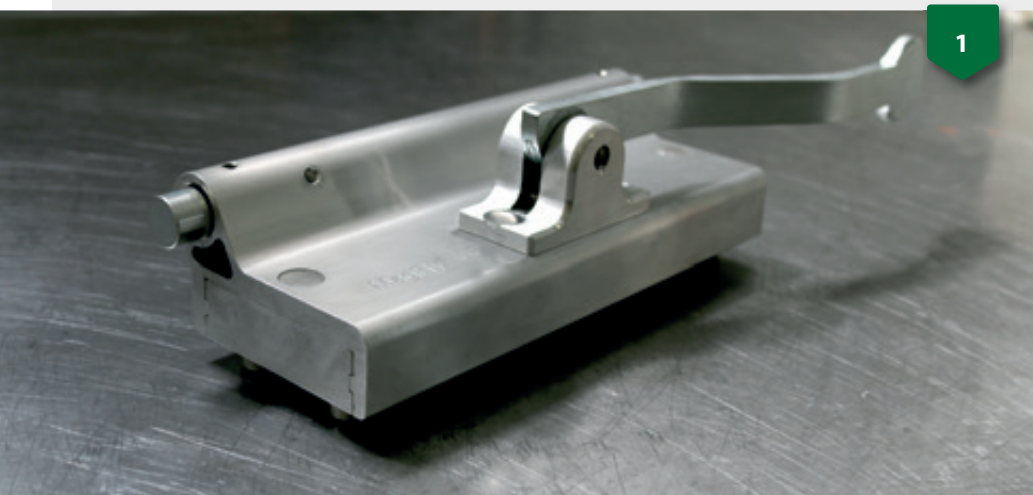

MultiForm / Window and Doorshuttering

THE INNOVATIVE SHUTTERING STRUCTURE SYSTEM

MultiForm is an innovative and universally applicable shuttering support system for the production of solid walls, sandwich walls, platform boards, and balcony boards; it also supports trusses, ties and much more. With MultiForm, you simplify your shuttering construction. The front of the shuttering carrier is panelled with wood, chipboard, plastic or steel. It is screwed in from behind. This allows the shell to remain unbroken; impressions of screw heads in the concrete part are a thing of the past. And in the case of exposed concrete surfaces, elaborate filling and sanding is no longer necessary.

The MultiForm takes over many tasks at once. Thanks to its supports, MultiForm ensures that your shuttering is at right angles. Thanks to its solid sheet metal construction, the shuttering is secure against torsion and bending. And, finally, the MutiForm has a magnetic pickup. MagFly® AP magnets are easily inserted into the shuttering carrier from behind. Now the shuttering and the magnets can be precisely positioned and sealed before they are permanently fixed in place by pressing the magnets down.

Benefits at a glance

- » Reduction of working time and material during construction of new shuttering
- » The low weight ensures easy handling - without a crane, in most cases
- » Magnets and shuttering girders are not firmly connected together, simplifying handling and allowing flexible use
- » Quick, easy and precise positioning by magnets with MagFly® technology
- » Shuttering heights between 10 and 80 cm can be achieved

Call for a quote!

*NEW MANUFACTURING TECHNIQUE

Image description:

1. Window and door shuttering
2. Column form, 80 cm height

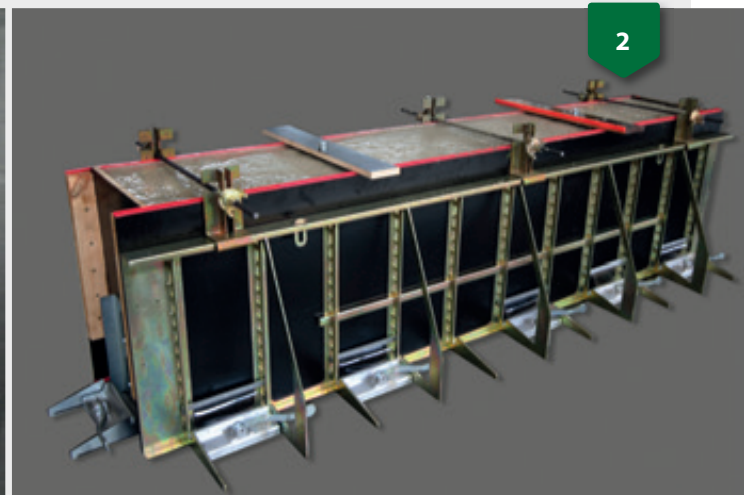
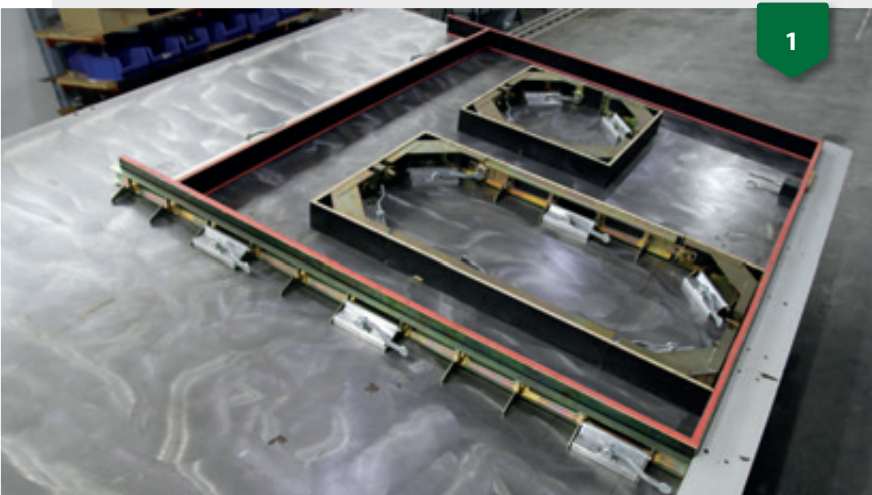

MagFly® Technology

OUR PATENT FOR YOUR EFFICIENCY

The MagFly® Universal Magnet is a true classic. It was the first magnet ever to be fitted with the patented MagFly® functionality, to which it ultimately not only owes its name but its success.

MagFly® universal magnets are extremely versatile. Two threaded holes measuring M16x1.5 are available as standard for mounting adapters and accessories. Alternative threaded positions and sizes are available upon request. The different adhesive forces, sizes and designs also ensure that the right adhesion magnet is available for different applications.

MagFly® universal magnets can be used at ambient temperatures of up to 80 °C. If desired, special heat-resistant versions are possible, e.g. for temperatures up to 120°C (TYPE H) as well as 150°C (TYPE SH).

High-quality materials and the torsion-resistant design ensure an extremely long service life. MagFly® universal magnets can be delivered with adhesive strengths of 11,000 N - 33,000 N.

Benefits at a glance

- » Extremely light and precise positioning, because the magnet virtually „slides“ on the tilting table or the steel pallet
- » Precise fixing of the magnet by slight hand pressure, only then does the full adhesive force enter into effect
- » Easy visual check to see whether the magnet is really „sitting“
- » The common industry practice of exact fitting using a hammer is no longer necessary, saving time, reducing wear and reducing costs
- » Compact construction without steel boxes or housing
- » Full utilization of magnetic holding force by direct non-positive connections between steel table, magnet and shuttering



Image description:

1. MagFly® adapter plate for coarse thread
2. Application for stair moulds
3. Corner solution

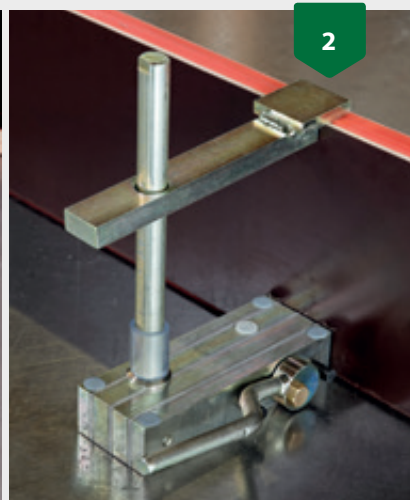
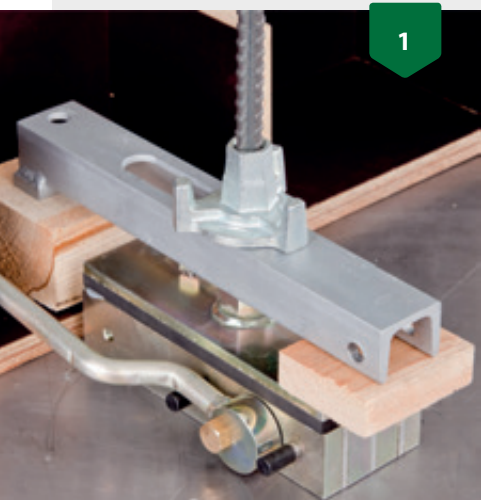

FlyFrame®

LIGHT SHELLS THANKS TO SIMPLE TECHNOLOGY

FlyFrame® is an ultra-strong yet very sturdy shuttering beam made of hardened and special-coated aluminium. The wood or chipboard shell can be screwed in from behind, so that the shell surface itself remains free of damage or screw heads. Large openings on the back of the FlyFrame® make it possible to attach difficult-to-install parts from the back.

In order to meet the demand for lighter weight and the associated easier handling, the adhesion magnets and shuttering beams are not firmly connected or even bolted together. The magnets are simply suspended from the rear into the shuttering beam according to the tried and tested principle.

Together with magnets, the shuttering can be precisely aligned before being permanently fixed by pressing down the MagFly® AP magnets. This makes the system easy to operate, very flexible and extremely economical.

Benefits at a glance

- » Low-cost
- » Extremely light! Long shuttering pieces can also be moved without a crane
- » Fast, precise work
- » No screws between magnet and shuttering - magnets are simply hung in
- » Fast amortisation



.....

Image description:

1. FlyFrame® in combination with MagFly® AP
2. Corner solution with FlyFrame®

.....

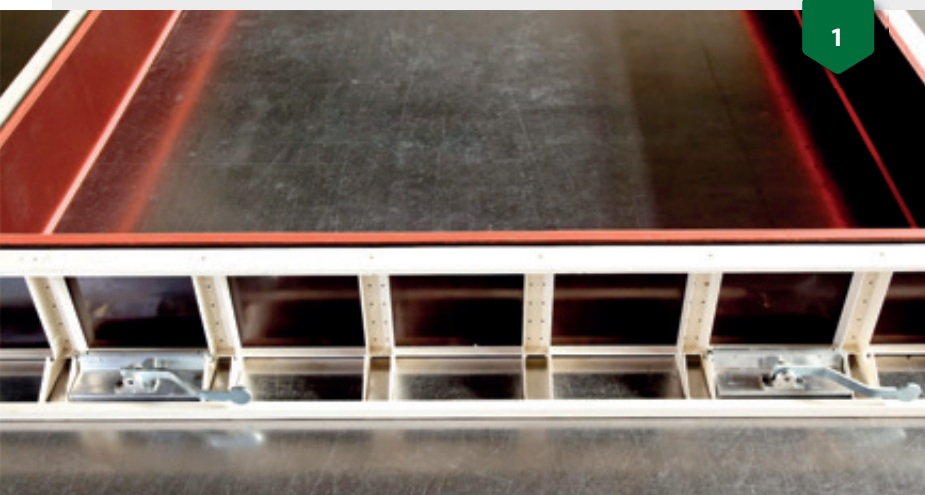

Overview of supports, pallets, special solutions

INDIVIDUAL AND FOR EVERY APPLICATION

MAGNETIC TRIANGULAR STRIPS

The triangular strips are available in steel and plastic and in different sizes, such as 10 x 10, 15 x 15 or 20 x 20. The standard length is 3,000 mm. Other lengths available upon request.



MAGNETIC TRAPEZOIDAL PROFILES

The trapezoidal profiles for shadow joints can be produced in steel and plastic in different sizes, such as (bottom width/top x height) 15/10 x 10; 20/10 x 10, 30/10 x 20, and 40/20 x 20. The standard length is 3,000 mm. Other lengths available upon request.

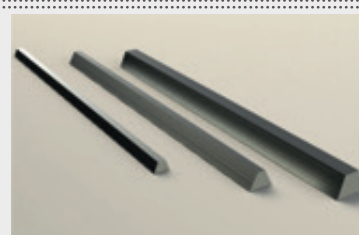

MAGFLEX®

The MagFlex® flexible shuttering system allows any desired rounding from a radius of 35 cm. Thanks to its individual components, the shuttering can easily be assembled and set up by a single person. Special magnetic solenoids with MagFly® technology ensure precise positioning and a secure hold.



MAGSWING®

MagSwing® is a shuttering system for element covers, double walls and special parts. The integrated magnets are stored in a special, patented design in such a way that they can be activated by the simple touch of a hand or foot. In order to be deactivated, the magnets are simply tilted in the U-profile using a lifter. When inactive, the MagSwing® can easily be taken off of the shell table.

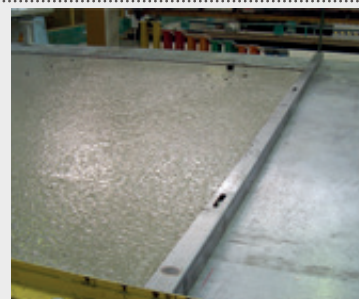

ALUMINIUM SHELL

The aluminium shuttering profile was especially developed for use as light-weight concrete formwork. This shell system consists of a hollow aluminium profile with switchable, integrated magnets. The aluminium profile, which is approx. 40 mm wide, is extremely space-saving and can be concreted on both sides since the magnets are installed in the shell. This makes it possible to optimally utilize the area on the switching tables.



CROSSWISE SHUTTERING, U-PROFILES & MORE

We offer U-profile pallets with and without integrated magnets, crossbars and solid wall shuttering as well as special magnets and much, much more. We will develop the optimal solution for you according to your specifications - high-quality steel bases with a high-performance magnetic core.

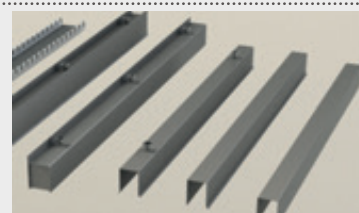

Overview of further magnet technology

INDIVIDUAL AND FOR EVERY APPLICATION

MAGNET TYP BR

The BR is a magnet specially developed for use in transversal and longitudinal stops and is mainly used in connection with U-shaped scaffolds in element ceiling and double wall production.

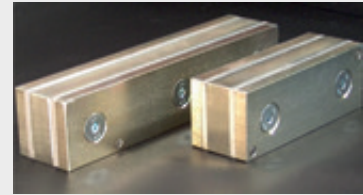

MAGNET TYP GB

The magnetic Type GB is used to fix threaded sleeves, shaft anchors, etc. on both horizontal and vertical surfaces. It is available in different diameters and with different adhesive forces.



MAGNET TYP KU

The magnetic Type KU is used to hold ball-head anchors. We have the right magnets with the optimum adhesive force in our programme, depending on the size of the ball-head anchors. In order to combine the ball-head anchor with the magnets, the right adhesive rubber is supplied for each case.



MAGNET TYP FP

The FP magnetic spring holder has been especially developed for the installation of fibreglass concrete uprights. Due to its compact design, it is equally suitable for small recesses or light edge shuttering made of wood.

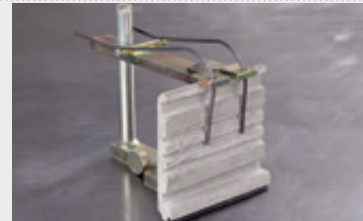

MAGNET TYP PL/E

The PL/E adhesion magnet consists of a solid plastic housing with an adhesive magnetic disc. Ideal applications include shuttering additions as well as window or door recesses made of wood or aluminium.

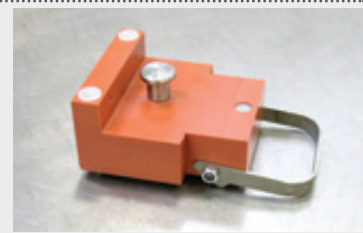

MAGNET TYP E NMT*

The magnet Type E is used for electrical outlet recesses. It has a high-quality steel base body with a high-performance magnetic core and can be moved and positioned.



***NEW MANUFACTURING TECHNIQUE**

Shuttering Manipulator

CABLE HOIST AND INTERLOCKING LOAD CAPACITY

The shuttering manipulator essentially consists of an extremely fast cable hoist, which is suspended from light aluminium rails on a non-driven x/y traversing device. The trolley and/or bridge are set in motion by a diagonal pull on the manipulator handle. The lifting motor is controlled by an upwards or downwards pulse. This combination allows the load to be easily moved along all three axes.

The cable also allows the shuttering elements to be effortlessly rotated around the z-axis. The cable hoist is operated with one hand. If necessary, the other hand can be used to balance or guide the shuttering.

The shuttering manipulator is designed for shuttering weights of up to about 75 kg. It is thus equally suitable for relatively lightweight U-shuttering for element ceiling and double wall construction, as well as for solid wall shuttering (e.g. based on MultiForm or FlyFrame®). Other load levels (up to 300 kg) available upon request.

Benefits at a glance

- » Short start-up time
- » Easy-to-operate, convenient cable hoist on the light crane system
- » Lifting is intelligently, immediately and precisely controlled by simple hand movements on the control handle
- » Can be used with various different shuttering types and sizes
- » Easy and fast shuttering installation via form-fitting load acceptance
- » Carrying capacity of 80 kg and variable effective lift (other load levels optional)

*NEW MANUFACTURING TECHNIQUE

Image description:

1. Setting the formwork
2. Handling
3. Manipulator plus magazine



1



2



3

Battery and Butterfly Formwork

HORIZONTAL PREPARATION AND VERTICAL MANUFACTURING

The advantages of horizontal and vertical production combined.

Butterfly formwork is a new and innovative type of formwork which is used in the production of pre-cast components. In combination with battery formwork, such formwork maximises processes and reduces timescales.

Butterfly formwork can be prepared horizontally e.g. using negative formwork, reinforcement, insulation or special components and cast within the battery in a horizontal or vertical position. Manufacturing in the battery has the advantage that smooth surfaces are produced on both sides of the formwork.

As the butterfly formwork can be replaced quickly, turn-around times are reduced, guaranteeing mass production on an individual basis.

Benefits at a glance

- » Mobile or on-site manufacturing
- » Powerful volume output with a relatively low surface area
- » Simple and easy to handle production process
- » Double-sided smooth-finish surfaces
- » Horizontal preparation

* * *

Gladly, we will send you further information.

*NEW MANUFACTURING TECHNIQUE

Image description:

1. Battery mould and butterfly formwork
2. Removing of the finished element outside the battery
3. Opened butterfly with matrices and recess

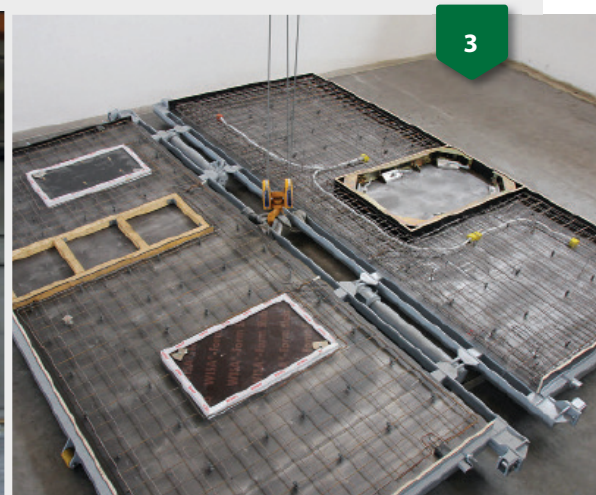
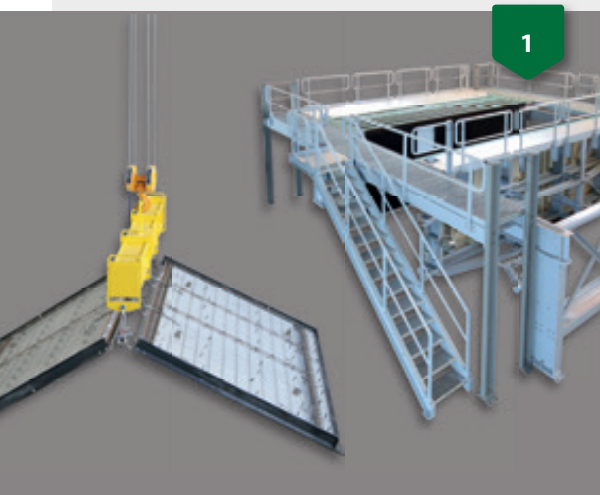

Unlimited imagination ...

GUIDES OUR WORK POWER
AND PERFORMANCE DRIVE US TO OUR
GOAL. WE OFFER OUR CUSTOMERS
EXTRAORDINARY SERVICES!

*Construction of a media channel
Pumped-storage power plant Reisseck
BT-Products: BT-Spannschloss®
und RubberElast®*

Consulting

INDIVIDUAL AND HOLISTIC CONCEPTS FOR PRECAST PLANTS

The optimisation of organisational and production processes within precast plants is gaining in significance.

Regardless of whether it is a question of reviewing and improving organisational processes, IT structures, material and information flow, planning capacity expansion or constructing new production facilities – with our extensive technological expertise and personal experience, we can help you to develop customised solutions for your project – efficiently and independently of manufacturers.

*We are there for you!
Get in touch.*

Image description:

1. Planning and realization of your projects
2. Analysis of working processes

What we offer

PLANNING

- » Feasibility studies and concepts for new-build precast plants
- » Economic analysis for existing and new production plants
- » Planning and optimisation of new production plants and machinery

ANALYSIS

- » Process analysis of work processes, organisation and information flows
- » Inspection and optimisation of EDP systems in administration and production
- » Verification of capacity and performance of plants and machinery

IMPLEMENTATION

- » Consultancy, planning, supply, commissioning of complete precast plants
- » A contact partner for all phases of planning, implementation and commissioning



1



2

Low Cost Housing

INNOVATIVE TECHNOLOGY FOR COST-EFFECTIVE LIVING IN JUST 2 HOURS

The “Low Cost House” concept is the ideal solution for rapidly-growing, low-income demographic groups who need high quality living space. Governments and aid organisations which need to provide quick first aid in crisis areas with high numbers of refugees or after natural catastrophes can provide secure accommodation using the Low Cost House.

The building concept developed by B.T. innovation for a solid concrete house provides a quick solution to provide accommodation for people in need. A Low Cost House can be constructed in just 2 hours, providing secure, stable and cost-effective living and utility space.

Benefits at a glance

- » Very quick construction
- » Solid/concrete
- » Optimised space partitioning
- » Designed for 4-6 people
- » Can be disassembled

36 m² in 2 hours

Extent up to 64 m²

Ask us for more information!

*NEW MANUFACTURING TECHNIQUE

Image description:

1. Low Cost House Prototype 2 with battery mould
2. Completely furnished Low Cost House



